



## LIVEWELL CONTROL SYSTEMS

Each Flow-Rite livewell control system consists of a drain control valve, control cable and premium control cable actuator. All component parts are of materials suitable for both fresh and saltwater applications.

### SYSTEM 1 REMOTE DRAIN SHUT-OFF



Provides remote drain control and eliminates need for drain plugs and standpipes. Short 60° cable throw is very smooth. Dual seals for positive shut-off. Straight unrestricted path through large valve ports eliminates clogging.

### SYSTEM 2 2-POSITION AUTOMATIC



System 2 features a very unique valve that eliminates the need for separate recirculating and fill pumps. Keeps plumbing and electrical parts to a minimum while providing truly automatic features not possible to achieve with any competitive system. Ideal for low profile bass boat configurations. Effortless cable operation.

### SYSTEM 3 3-POSITION AUTOMATIC



All the automatic features of System #2, but with a third position of closed recirculation for those rare occasions when outside water may not be desirable, such as when refueling at dockside, using livewell additives, or when used in conjunction with System #5 pump-out valve.

### SYSTEM 4 3-POSITION SELECT



Designed for higher profile boats where the livewell / baitwell overflows are elevated substantially above lake level, such as common on center console offshore boats. Primary operating mode is closed recirculation. Provides selection of drain control, fresh filling, or closed recirculation, and aeration all with a single pump.

### SYSTEM 5 PUMP-OUT



This system's valve is inserted into the aeration hose between the recirculating pump and the aerator. A rotary actuator allows the operator to select normal recirculation or "Pump-Out" which allows the pump to lower the water level of the livewell to aid in fish removal. Especially useful at tournament weigh-ins. Can be used with systems 1, 3, and 4 without any additional pumps.

## FLOW-RITE SYSTEM 1 REMOTE DRAIN SHUT-OFF

### OPEN - ON/OFF-PLANE

The "OPEN" position is primarily used to drain the livewell after all aerator pumps have been turned off. In this position, both valve ports are wide open for a straight unobstructed path through the control valve. This straight shot coupled with the fact that the inside diameter of the valve ports are larger than those of the drain fitting prevents debris from becoming clogged in this area. Competitive "disk" style valves require (4) very sharp 90° turns inside the valve that can become a trap for livewell debris.



### CLOSED - ON/OFF-PLANE

The "CLOSED" position is used to seal the livewell drain in order to maintain a full livewell. By putting the control cable in the "CLOSED" position prior to launching, it can also be used to prevent the water from entering the livewell until desired. This is the preferred method of operation in tournament competition as some livewells may hold two or three hundred pounds of water. When in the "CLOSED" position, it is only necessary to turn on the fresh fill aerator pump once the first fish is caught.

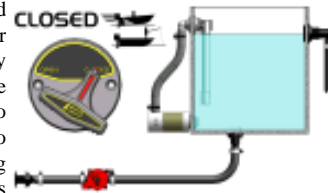

*Note: Typically the system illustrated above would also require a transom mounted pump for filling. This pump has been omitted from the drawing for clarity. Systems #2, 3, and 4 do not require separate fill pumps.*

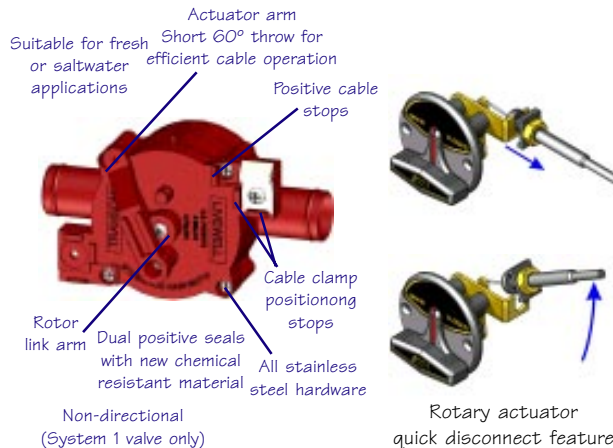

## FLOW-RITE SYSTEM 2 2-POSITION AUTOMATIC

### AUTO - OFF-PLANE

Once the first fish is caught, simply place the rotary actuator in the "AUTO" position, turn on the aerator pump and forget it. With the boat off plane, fresh water will be constantly blended with recirculated livewell water. This ensures a properly filled and freshened livewell at all times and that any ammonia laden used water is expelled through the overflow.

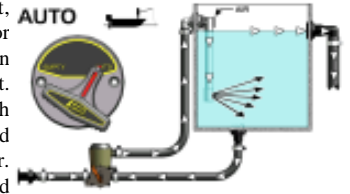

### AUTO - ON-PLANE

When the boat is placed on plane, the control valve will automatically close the transom port to prevent water loss and the aerator pump is automatically diverted to closed recirculation duty. When the next fishing spot is reached and the boat is brought off plane, the control valve automatically opens the transom port to again allow fresh oxygenated water to be added to the livewell. Therefore, any water that was lost through the overflow while running from spot to spot is automatically made up without any operator assistance.

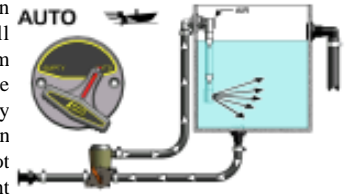

### EMPTY - ON/OFF-PLANE

The "EMPTY" position is, of course, used for draining the livewell. It is, however, much more than just an open drain position. When placed in the "EMPTY" position, the control valve allows water to exit the transom drain, but not enter. This check feature is most appreciated by the tournament angler, who in the wee hours of the morning, does not have to remember to close a livewell drain prior to launching as the control is already in the "EMPTY" position. Water will automatically be prevented from entering the livewell as the boat is backed into the water. No more blast-offs with hundreds of pounds of unwanted water in the livewell.

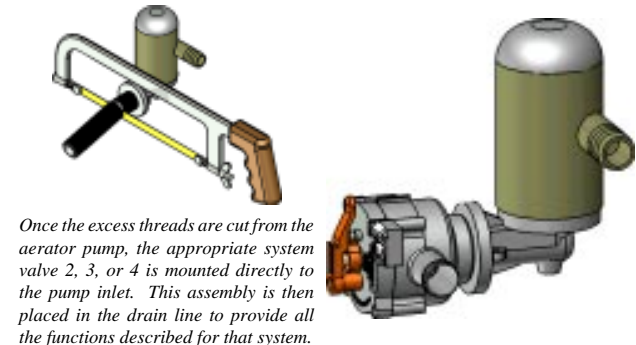
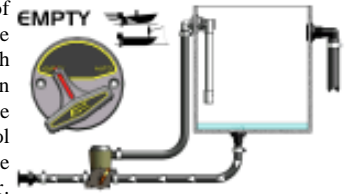

## FLOW-RITE SYSTEM 3 3-POSITION AUTOMATIC

### AUTO - OFF-PLANE

Once the first fish is caught, simply place the rotary actuator in the "AUTO" position, turn on the aerator pump and forget it. With the boat off plane, fresh water will be constantly blended with recirculated livewell water. This ensures a properly filled and freshened livewell at all times and that any ammonia laden used water is expelled through the overflow.

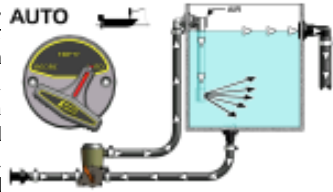

### AUTO - ON-PLANE

When the boat is placed on plane, the control valve will automatically close the transom port to prevent water loss and the aerator pump is automatically diverted to closed recirculation duty. When the next fishing spot is reached and the boat is brought off plane, the control valve automatically opens the transom port to again allow fresh oxygenated water to be added to the livewell. Therefore, any water that was lost through the overflow while running from spot to spot is automatically made up without any operator assistance.



### RECIRCULATE - ON/OFF-PLANE

The "RECIRC" position is for those rare occasions when outside water may not be desirable. This may include refueling stops at dockside, and when using a livewell additive shortly before a tournament weigh-in. By placing the rotary actuator in the "RECIRC" position, outside water is prevented from entering while the control valve continues to allow the pump to recirculate and aerate the livewell. When outside water conditions improve, return to the "AUTO" position. This position is also used when trailering fish.

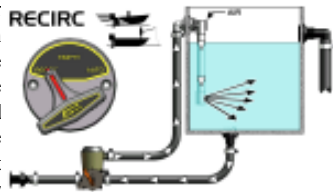

### EMPTY - ON/OFF-PLANE

The "EMPTY" position is, of course, used for draining the livewell. It is, however, much more than just an open drain position. When placed in the "EMPTY" position, the control valve allows water to exit the transom drain, but not enter.

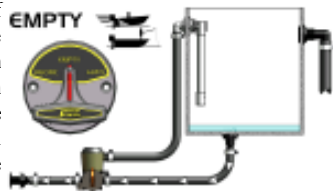

This check feature is most appreciated by the tournament angler, who in the wee hours of the morning, does not have to remember to close a livewell drain prior to launching as the control is already in the "EMPTY" position. Water will automatically be prevented from entering the livewell as the boat is backed into the water. No more blast-offs with hundreds of pounds of unwanted water in the livewell.

## FLOW-RITE SYSTEM 4 3-POSITION SELECT

### FILL - OFF-PLANE

Once the first fish is caught, simply place the rotary actuator in the "FILL" position and turn on the aerator pump. With the boat off plane and the rotary actuator in the "FILL" position, the transom port of the control valve opens to allow the pump to bring in fresh water. The livewell port of the valve is closed. This position is used primarily for filling and occasionally adding fresh water, but can be left in this position while fishing. It must, however, be moved to the "RECIRC" position before putting the boat on plane for proper recirculation and aeration while running. When the next fishing spot is reached and the boat is brought off plane, the control can again be placed in the "FILL" position to allow fresh oxygenated water to be added to the livewell and to replenish any water that was lost through the overflow while running from spot to spot.

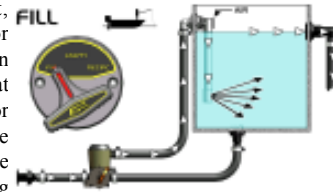

### RECIRCULATE - ON/OFF-PLANE

Once the livewell is filled to the overflow fitting, the rotary actuator can be moved to the "RECIRC" position for recirculation and aeration of the livewell water. This position can be used as the normal operating position and eliminates the need for the operator to move the control before running on plane. The control should be occasionally returned to the "FILL" position while off plane to ensure that any water that was lost out the overflow while running is replaced. This should also be done to ensure that any used ammonia laden water is forced out the overflow and replaced with fresh oxygenated water. The "RECIRC" position should also be used when outside water may not be desirable. This may include refueling stops at dockside, and when using a livewell additive shortly before a tournament weigh-in. The "RECIRC" position is also used when trailering fish.

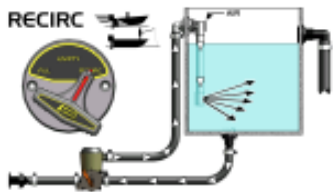

### EMPTY - ON/OFF-PLANE

The "EMPTY" position is, of course, used for draining the livewell. Turn off the aerator pump and place the control in the "EMPTY" position for draining. Return to the "FILL" position before the next launching to prevent water from entering the livewell until the pump is turned on.

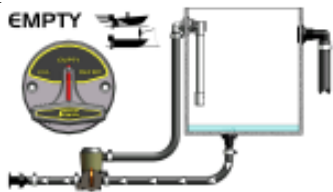

## FLOW-RITE SYSTEM 5 PUMP OUT

FOR USE WITH SYSTEMS 1, 3, 4, OR ANY CLOSED RECIRCULATION SYSTEM

### RECIRC - ON/OFF-PLANE

The "RECIRC" position is the normal operating position. In this position water from the recirculating pump is routed through the livewell aerator.

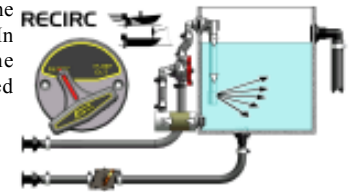

### PUMP OUT - ON/OFF-PLANE

The "PUMP OUT" position is used to lower the livewell level for easy removal of fish for a tournament weigh-in. Simply leave the recirculating pump running and move the rotary actuator to the "PUMP OUT" position.

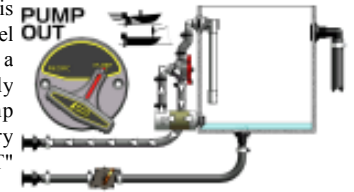

## FLOW-RITE AERATION

POWERSTREAM AERATOR

POWER-JET AERATOR

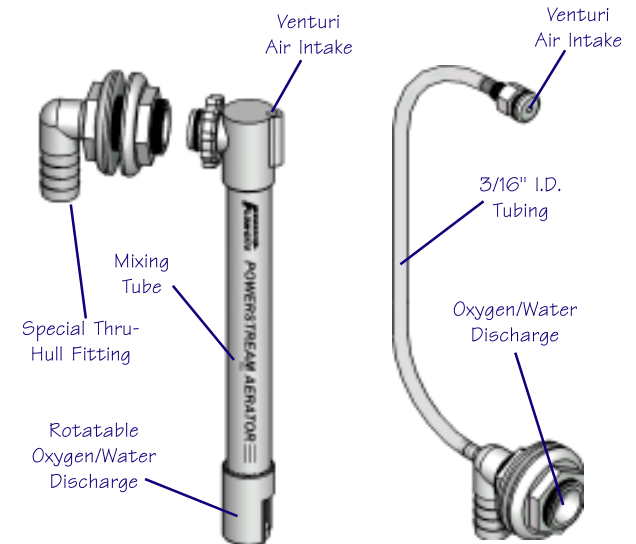

Flow-Rite Controls, Ltd.

960 74th St., Byron Center, MI 49315

Phone: (616) 583-1700 ~ Fax: (616) 878-5151

[www.flow-rite.com](http://www.flow-rite.com)